

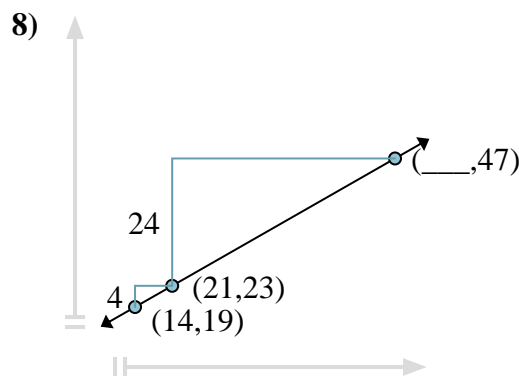

Find the missing coordinate in each problem.

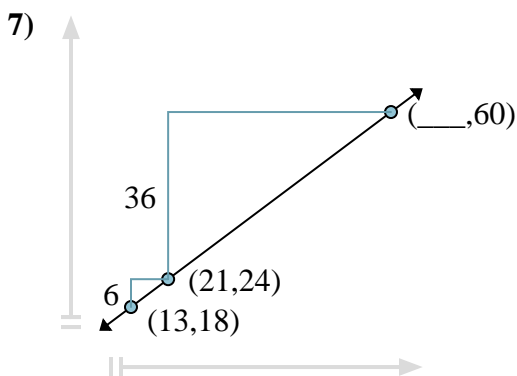
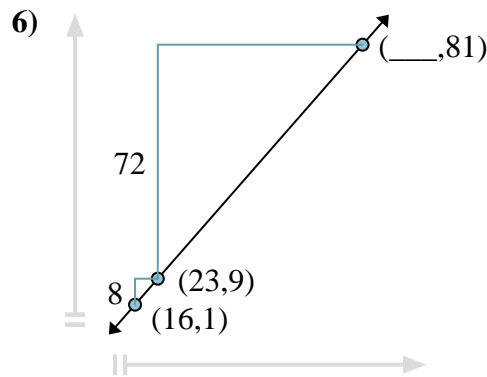
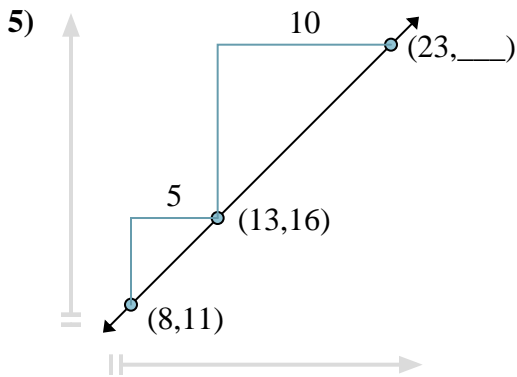
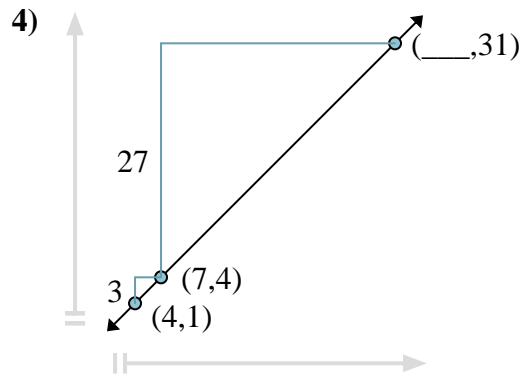
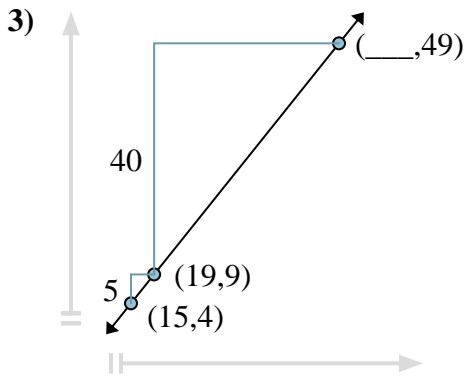
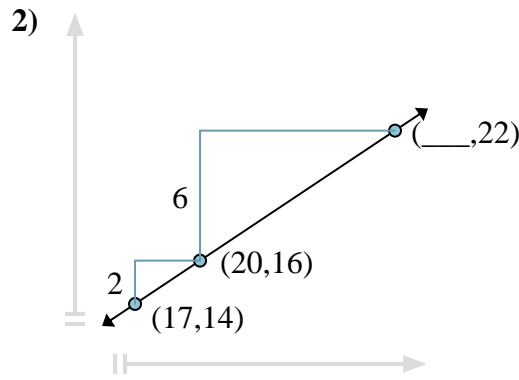
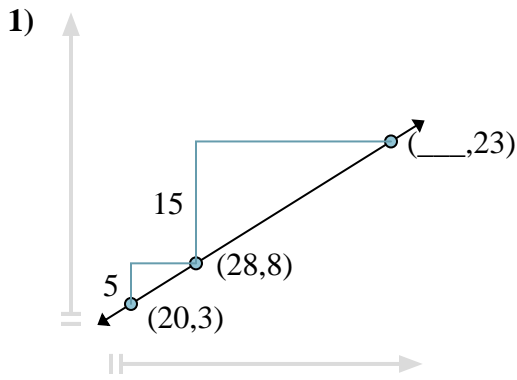

Answers

1. _____
2. _____
3. _____
4. _____
5. _____
6. _____
7. _____
8. _____



Find the missing coordinate in each problem.

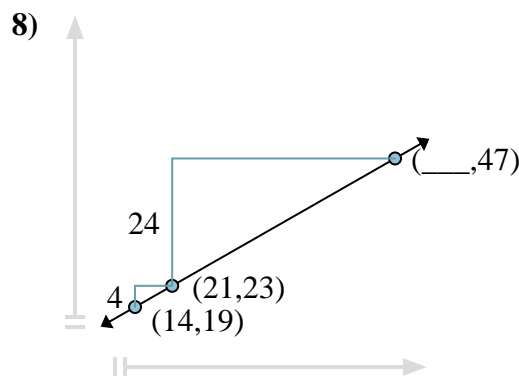
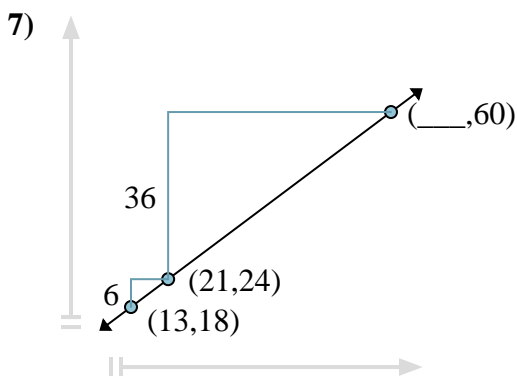
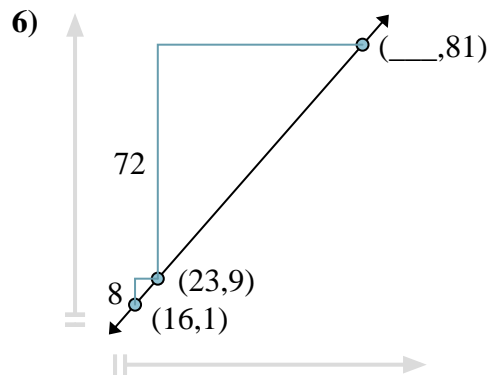
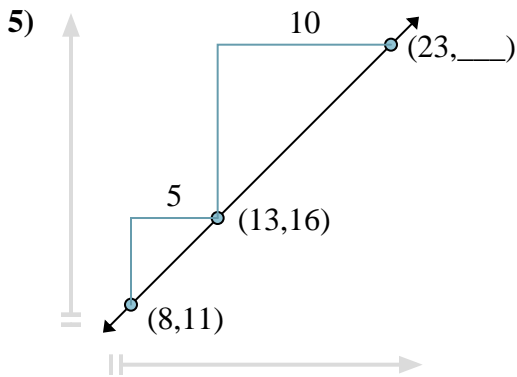
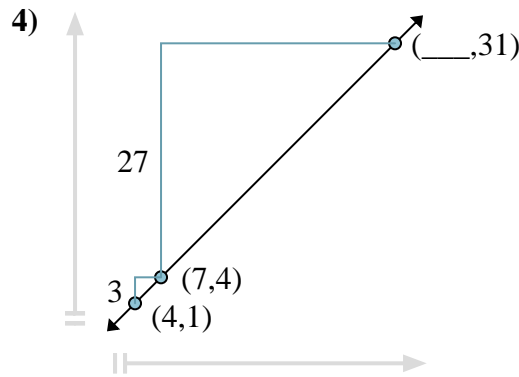
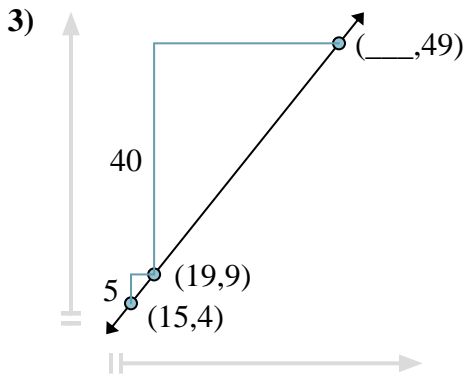
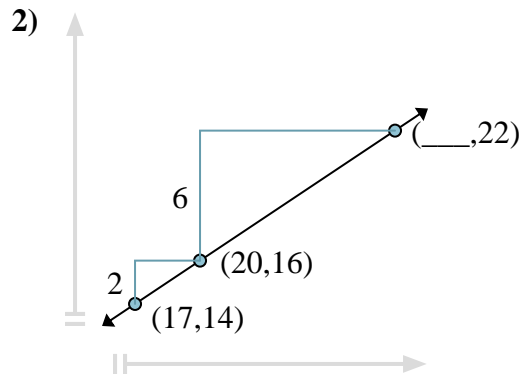
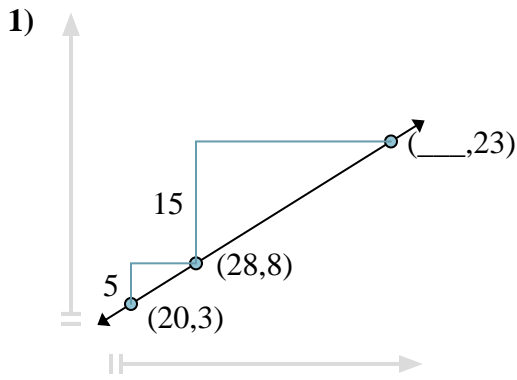

Answers

1. 52
2. 29
3. 51
4. 34
5. 26
6. 86
7. 69
8. 63