

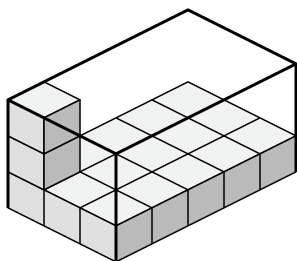

Determine the volume of each box. Each block is 1 cubic unit (u^3).

1)



2)

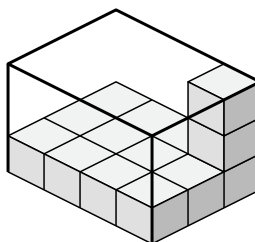

3)

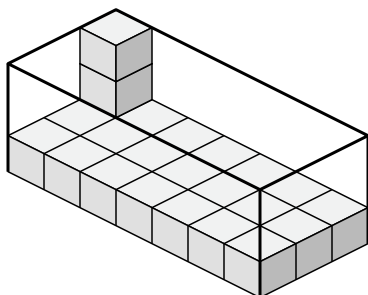

4)

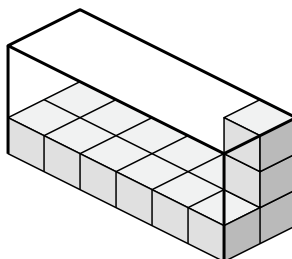

5)

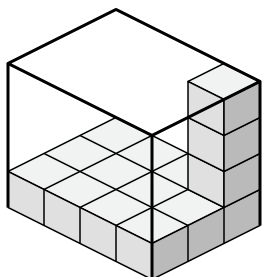

6)

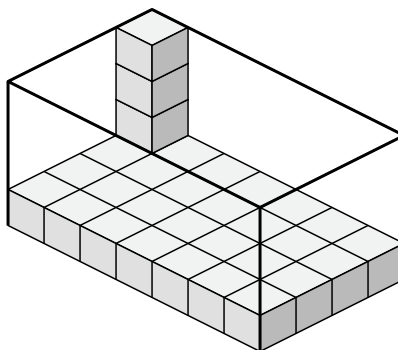

7)

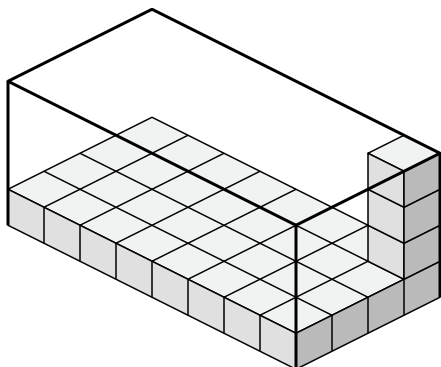

8)

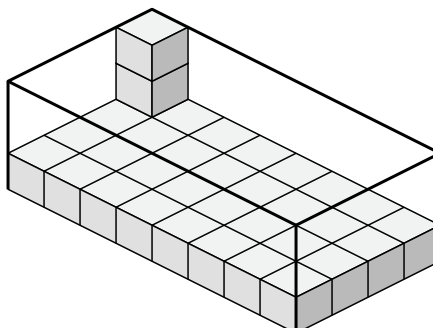

Answers

1. _____

2. _____

3. _____

4. _____

5. _____

6. _____

7. _____

8. _____



Determine the volume of each box. Each block is 1 cubic unit (u^3).

1)

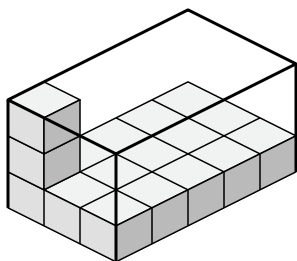

2)

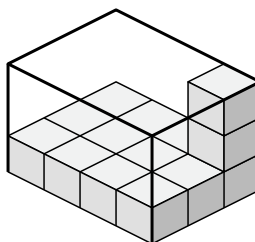

3)

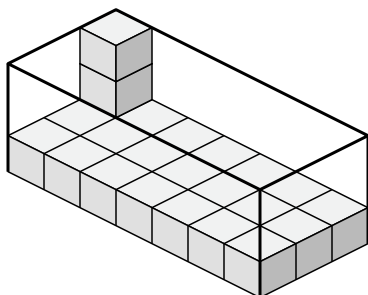

4)

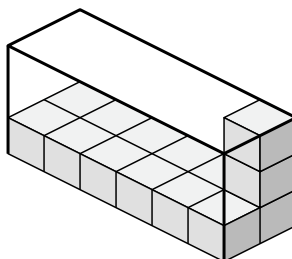

5)

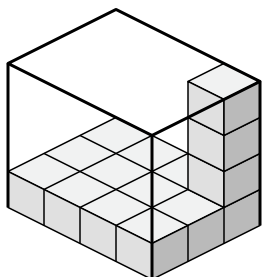

6)

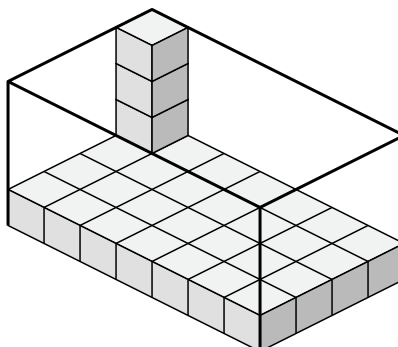

7)

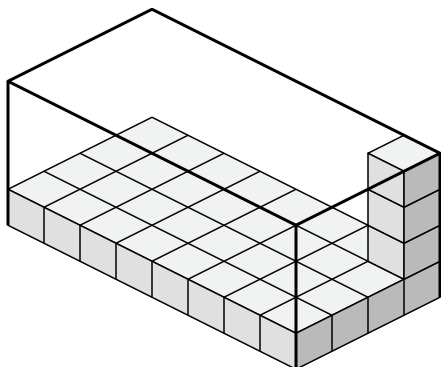

8)

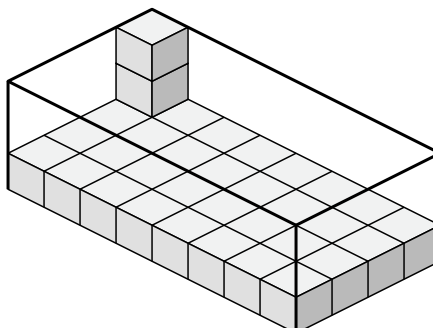

Answers

1. 45 u^3

2. 36 u^3

3. 63 u^3

4. 36 u^3

5. 48 u^3

6. 112 u^3

7. 128 u^3

8. 96 u^3



Determine the volume of each box. Each block is 1 cubic unit (u^3).

1)

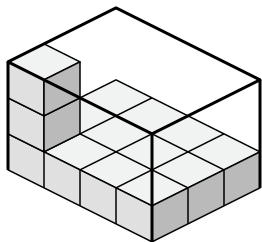

2)

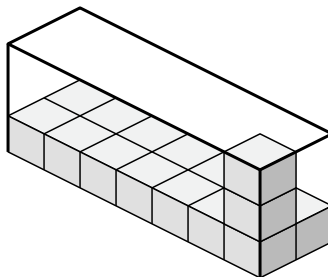

3)

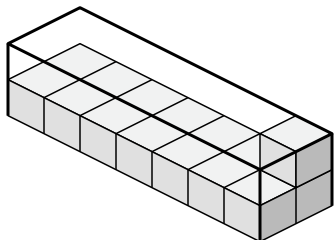

4)

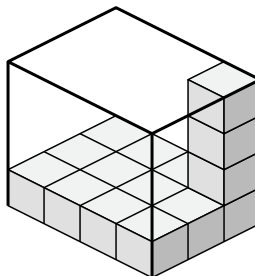

5)

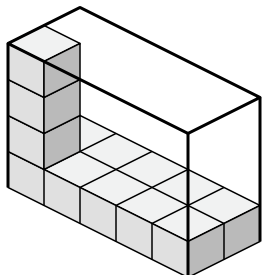

6)

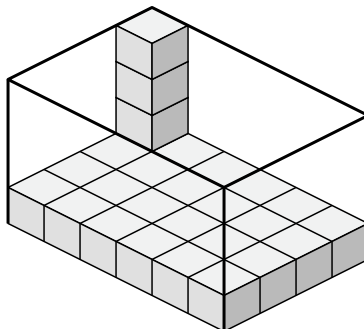

7)

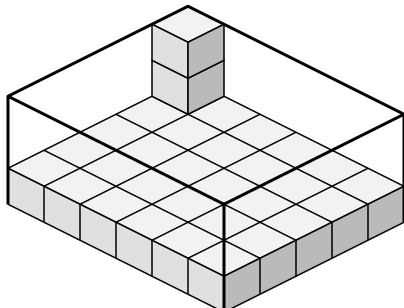

8)

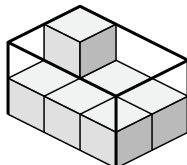

Answers

1. _____

2. _____

3. _____

4. _____

5. _____

6. _____

7. _____

8. _____



Determine the volume of each box. Each block is 1 cubic unit (u^3).

1)

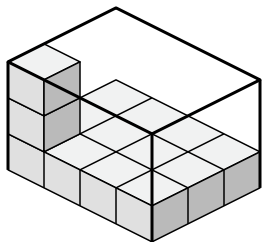

2)

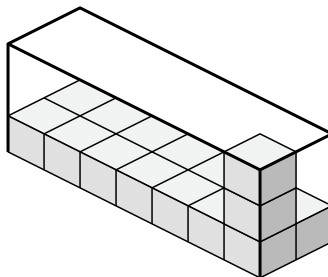

3)

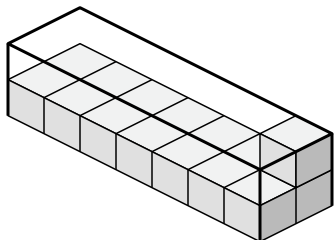

4)

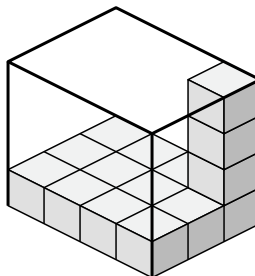

5)

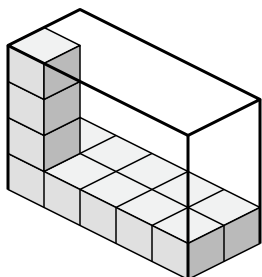

6)

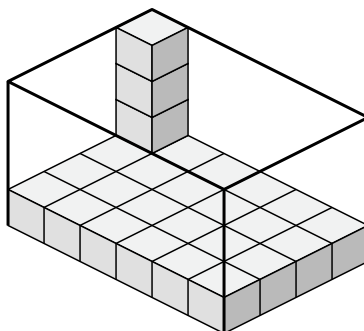

7)

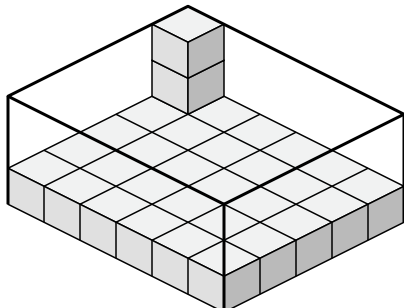

8)

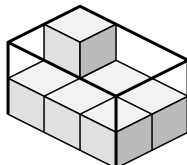

Answers

1. 36 u^3

2. 42 u^3

3. 28 u^3

4. 48 u^3

5. 40 u^3

6. 96 u^3

7. 90 u^3

8. 12 u^3



Determine the volume of each box. Each block is 1 cubic unit (u^3).

1)

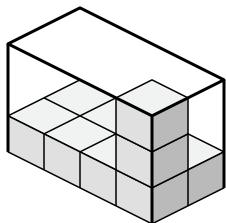

2)

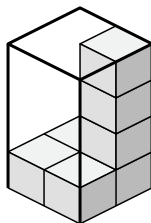

3)

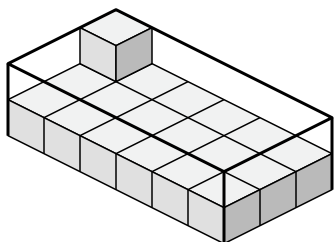

4)

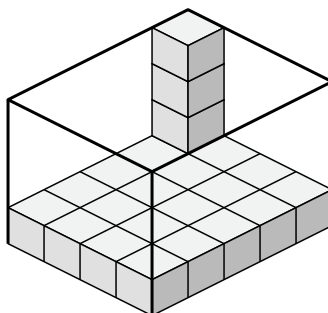

5)

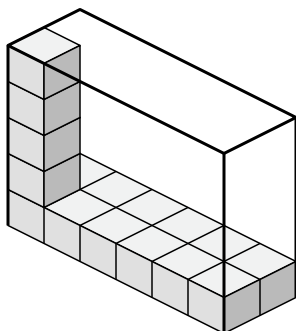

6)

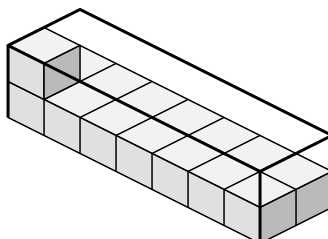

7)

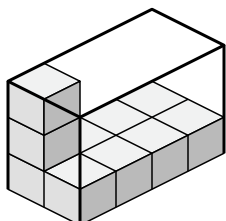

8)

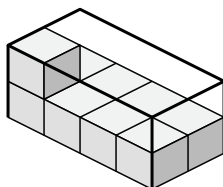

Answers

1. _____

2. _____

3. _____

4. _____

5. _____

6. _____

7. _____

8. _____



Determine the volume of each box. Each block is 1 cubic unit (u^3).

1)

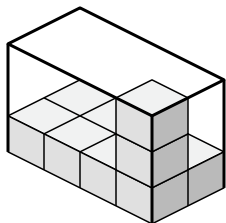

2)

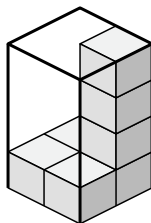

3)

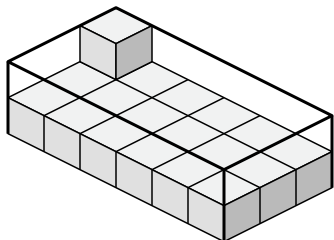

4)

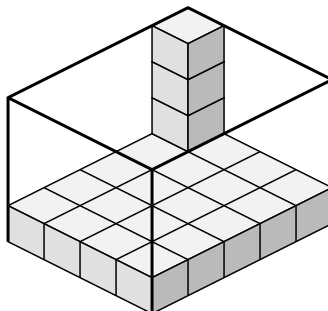

5)

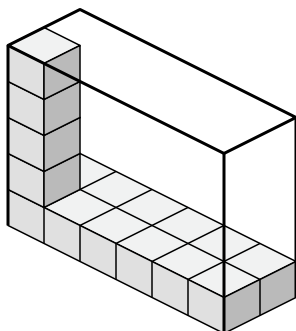

6)

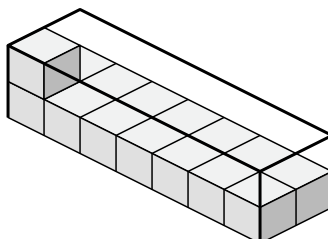

7)

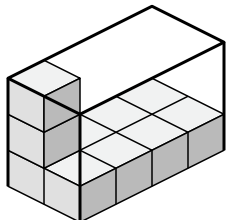

8)

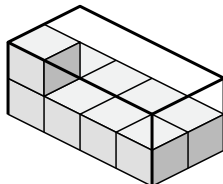

Answers

1. 24 u^3

2. 16 u^3

3. 36 u^3

4. 80 u^3

5. 60 u^3

6. 28 u^3

7. 24 u^3

8. 16 u^3



Determine the volume of each box. Each block is 1 cubic unit (u^3).

1)

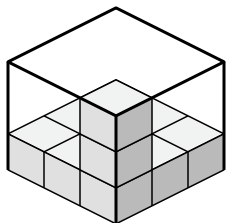

2)

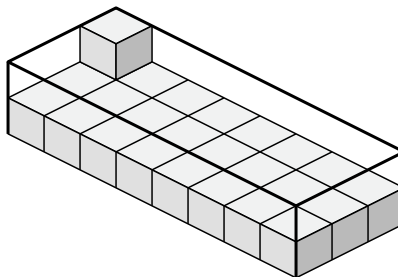

3)

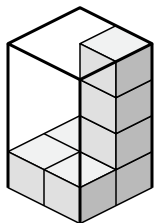

4)

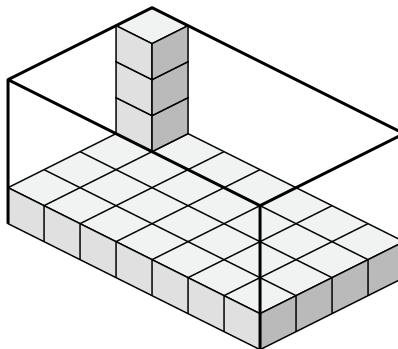

5)

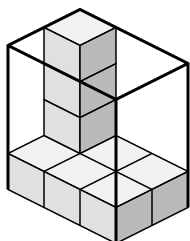

6)

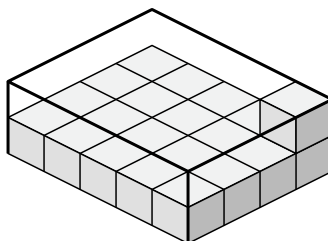

7)

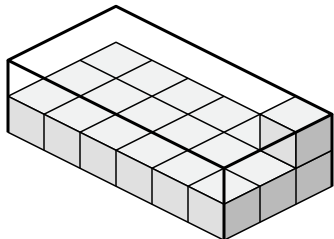

8)

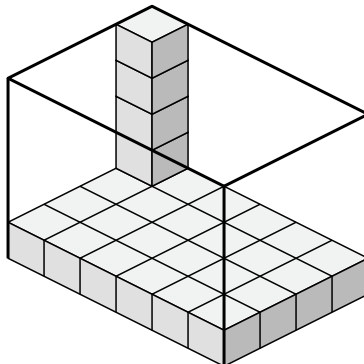

Answers

1. _____

2. _____

3. _____

4. _____

5. _____

6. _____

7. _____

8. _____



Determine the volume of each box. Each block is 1 cubic unit (u^3).

1)

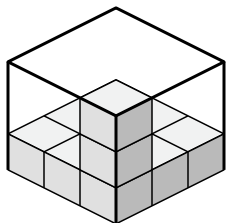

2)

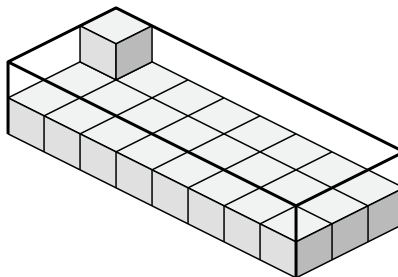

3)

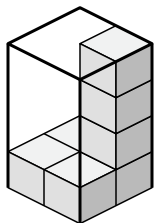

4)

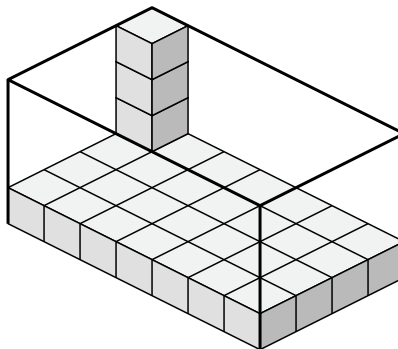

5)

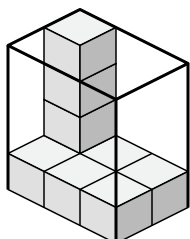

6)

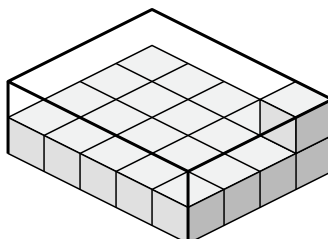

7)

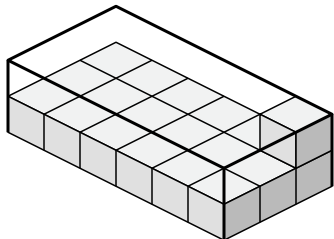

8)

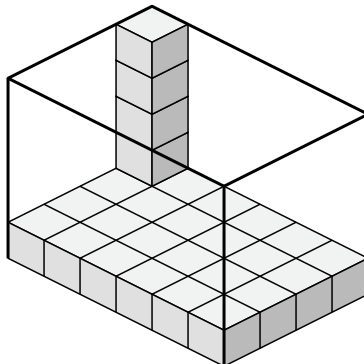

Answers

1. 27 u^3

2. 48 u^3

3. 16 u^3

4. 112 u^3

5. 24 u^3

6. 40 u^3

7. 36 u^3

8. 120 u^3



Determine the volume of each box. Each block is 1 cubic unit (u^3).

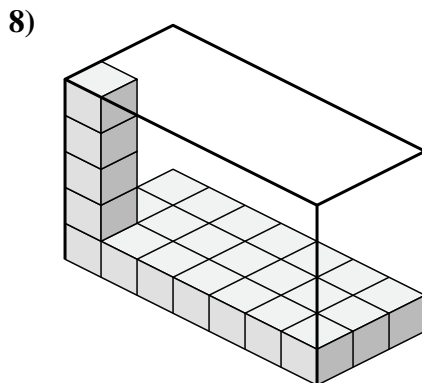
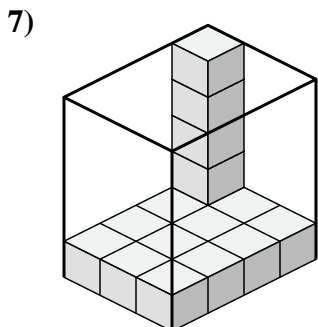
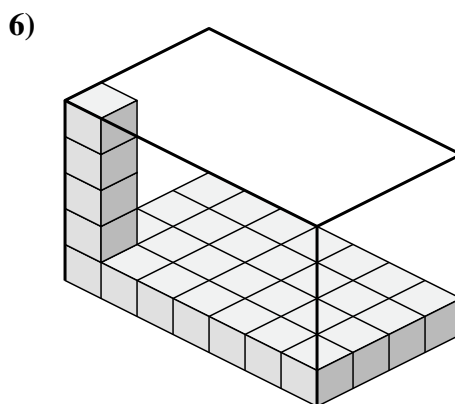
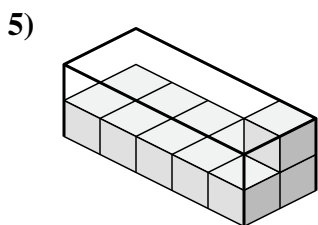
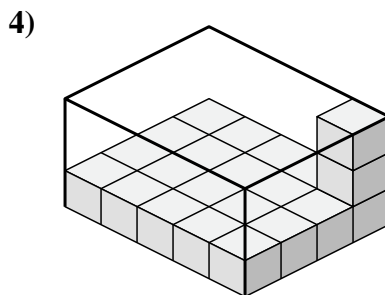
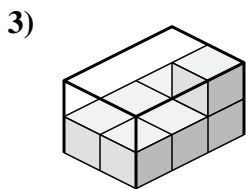
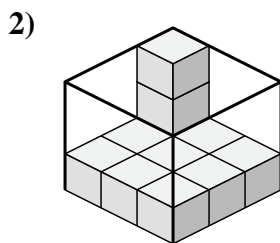
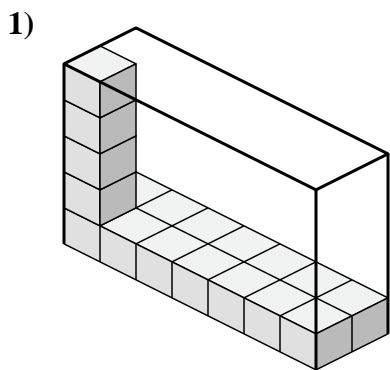

Answers

- 1. _____
- 2. _____
- 3. _____
- 4. _____
- 5. _____
- 6. _____
- 7. _____
- 8. _____



Determine the volume of each box. Each block is 1 cubic unit (u^3).

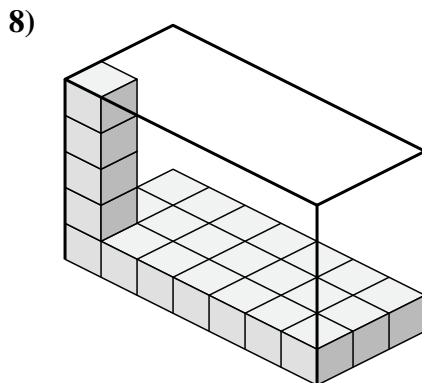
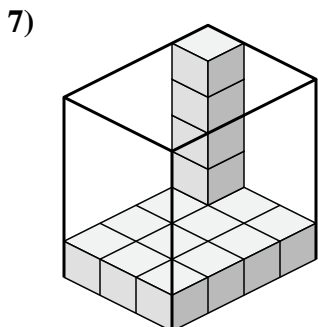
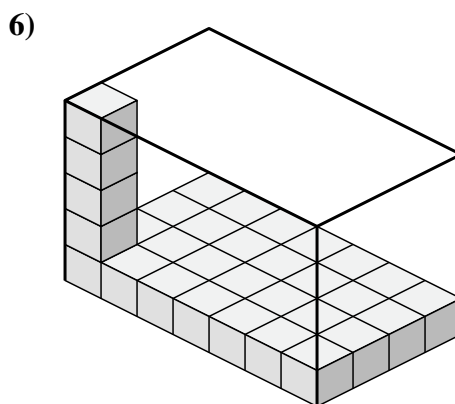
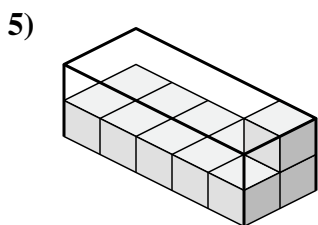
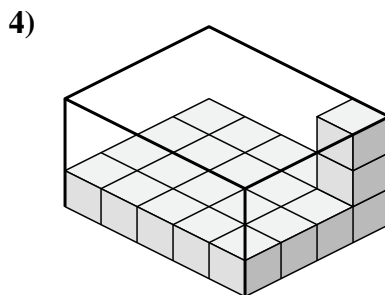
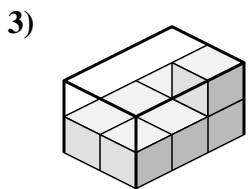
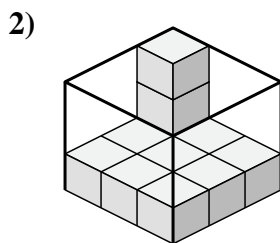
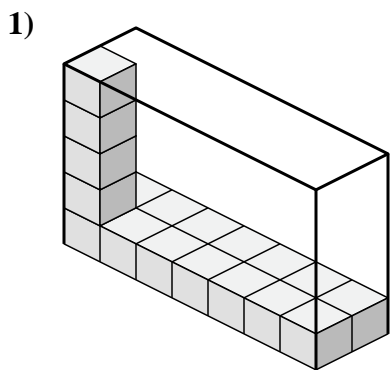

Answers

1. 70 u^3

2. 27 u^3

3. 12 u^3

4. 60 u^3

5. 20 u^3

6. 140 u^3

7. 60 u^3

8. 105 u^3



Determine the volume of each box. Each block is 1 cubic unit (u^3).

1)

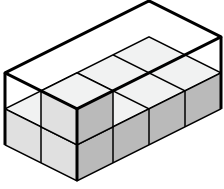

2)

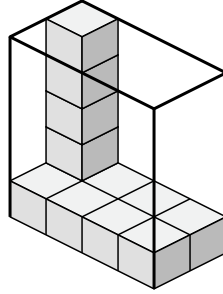

3)

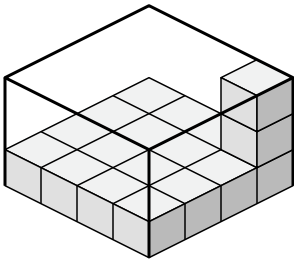

4)

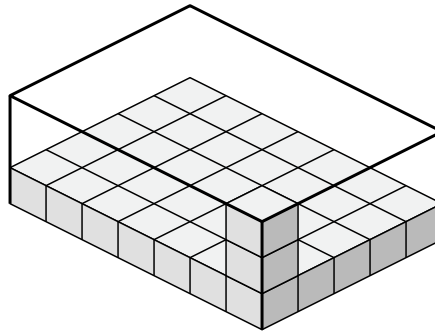

5)

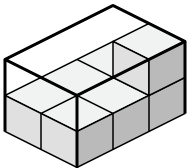

6)

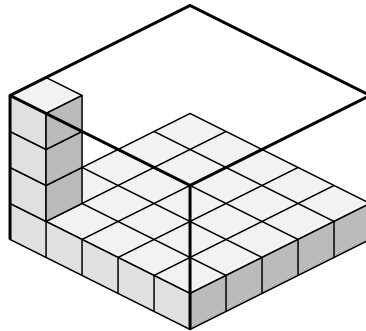

7)

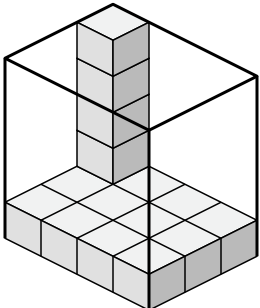

8)

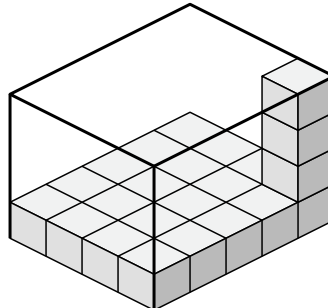

Answers

1. _____

2. _____

3. _____

4. _____

5. _____

6. _____

7. _____

8. _____



Determine the volume of each box. Each block is 1 cubic unit (u^3).

1)

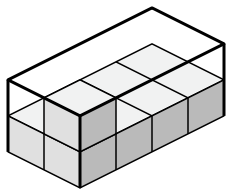

2)

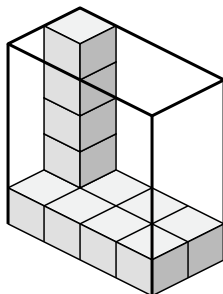

3)

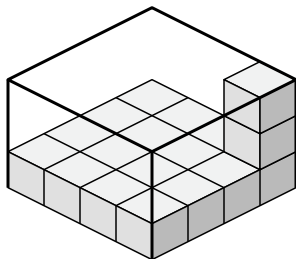

4)

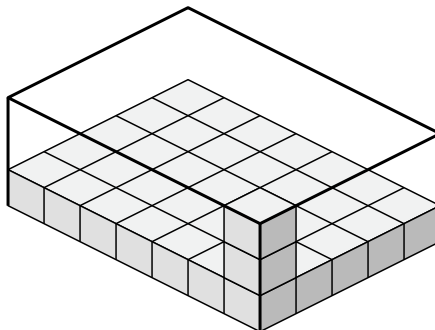

5)

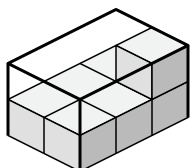

6)

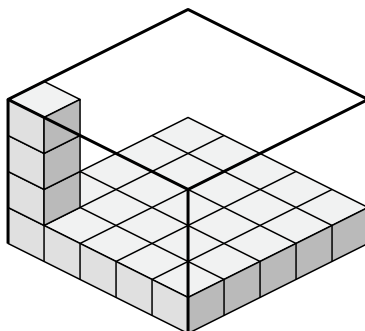

7)

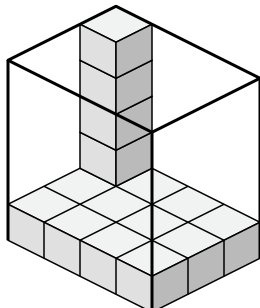

8)

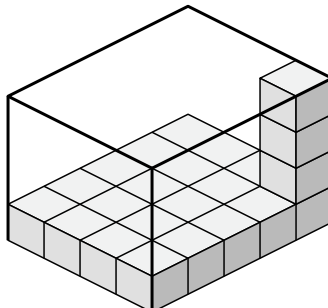

Answers

1. 16 u^3

2. 40 u^3

3. 48 u^3

4. 105 u^3

5. 12 u^3

6. 100 u^3

7. 60 u^3

8. 80 u^3



Determine the volume of each box. Each block is 1 cubic unit (u^3).

1)

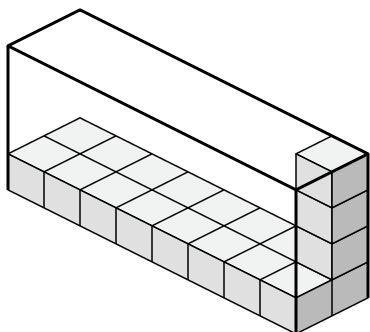

2)

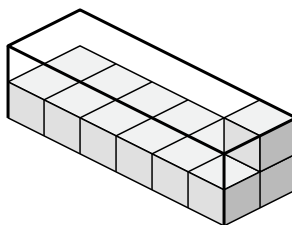

3)

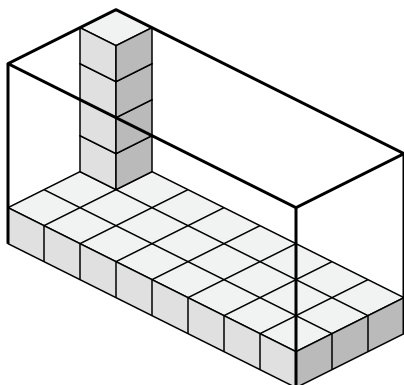

4)

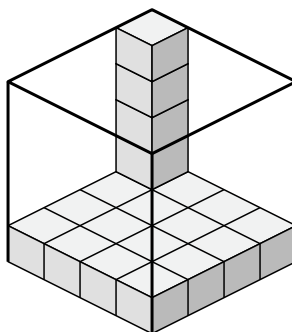

5)

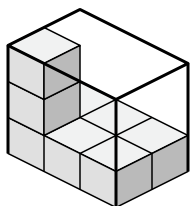

6)

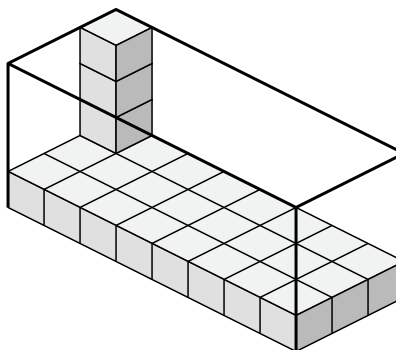

7)

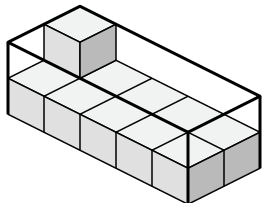

8)

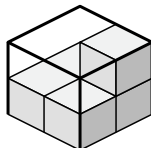

Answers

1. _____

2. _____

3. _____

4. _____

5. _____

6. _____

7. _____

8. _____



Determine the volume of each box. Each block is 1 cubic unit (u^3).

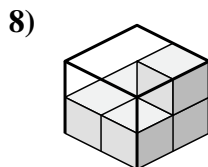
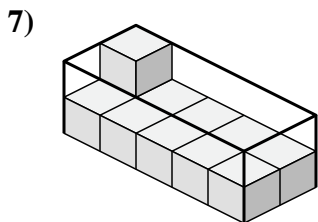
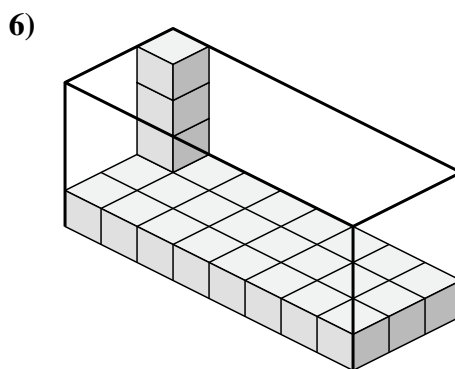
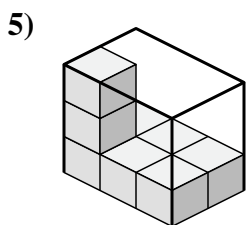
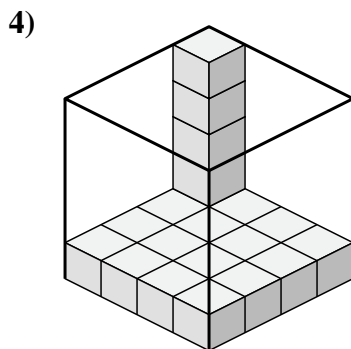
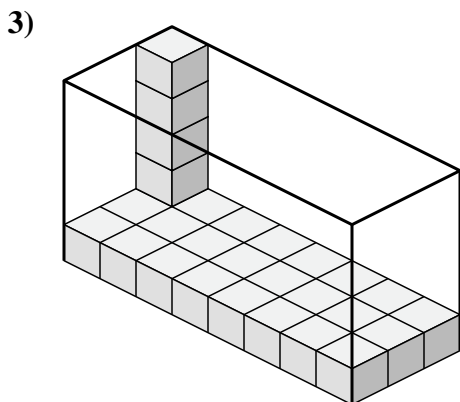
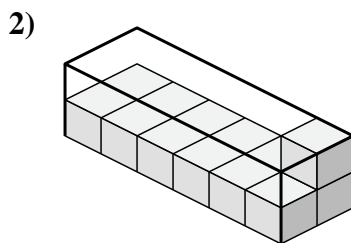
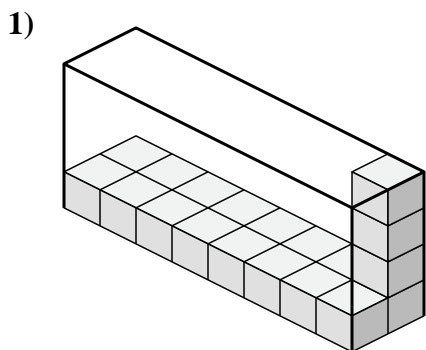

Answers

1. 64 u^3

2. 24 u^3

3. 120 u^3

4. 80 u^3

5. 18 u^3

6. 96 u^3

7. 20 u^3

8. 8 u^3



Determine the volume of each box. Each block is 1 cubic unit (u^3).

1)

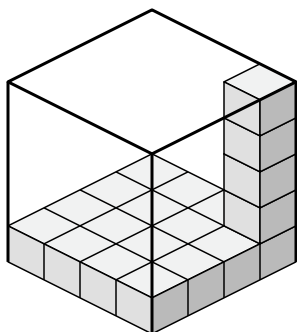

2)

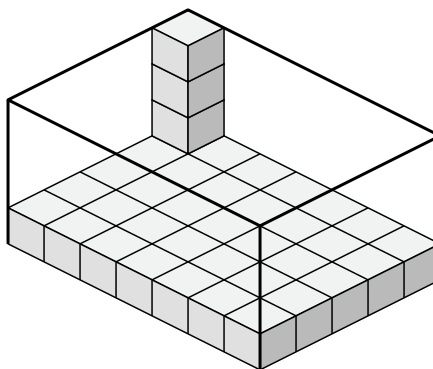

3)

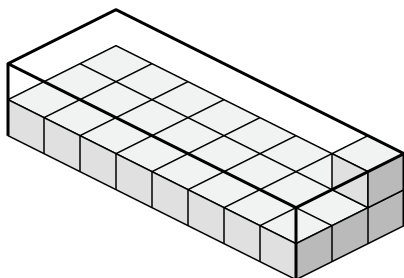

4)

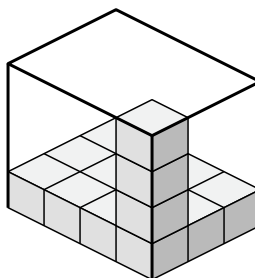

5)

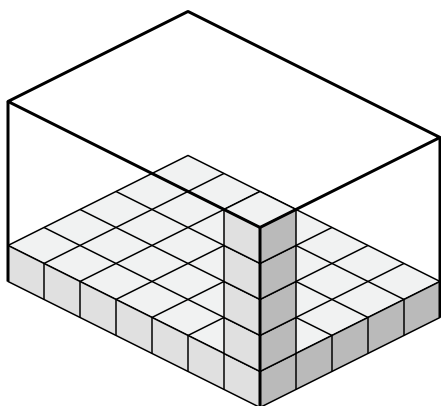

6)

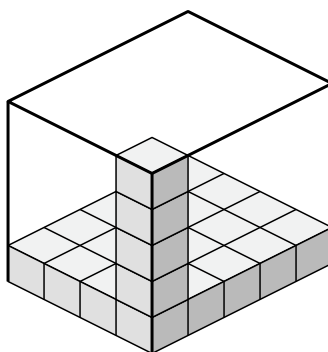

7)

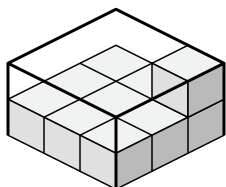

8)

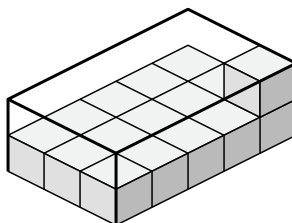

Answers

1. _____

2. _____

3. _____

4. _____

5. _____

6. _____

7. _____

8. _____



Determine the volume of each box. Each block is 1 cubic unit (u^3).

1)

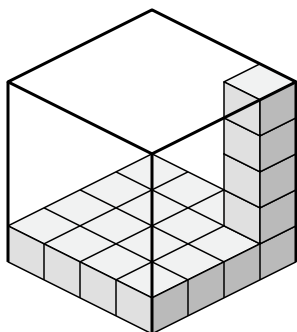

2)

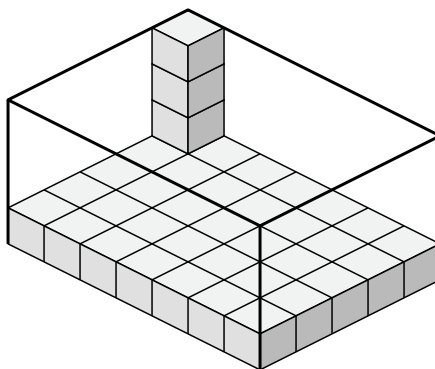

3)

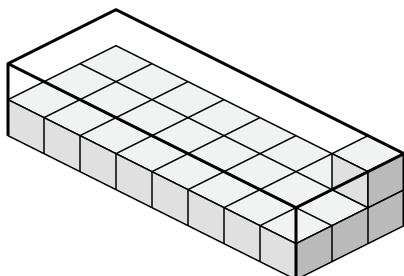

4)

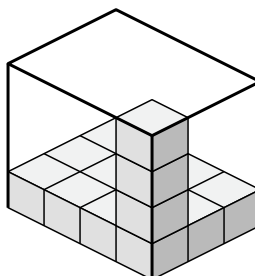

5)

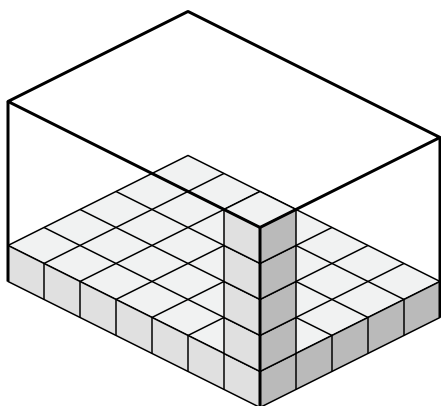

6)

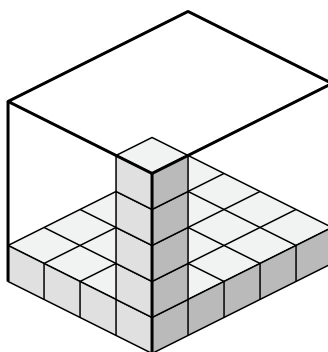

7)

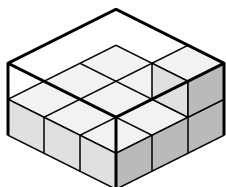

8)

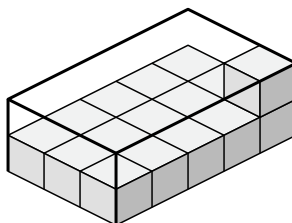

Answers

1. 80 u^3

2. 140 u^3

3. 48 u^3

4. 48 u^3

5. 175 u^3

6. 100 u^3

7. 18 u^3

8. 30 u^3



Determine the volume of each box. Each block is 1 cubic unit (u³).

1)

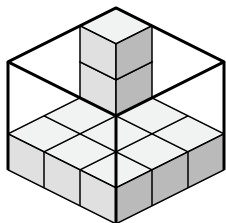

2)

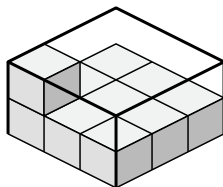

3)

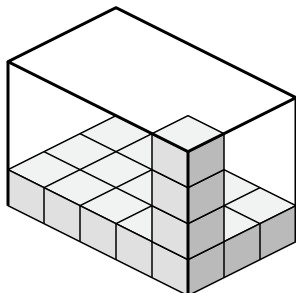

4)

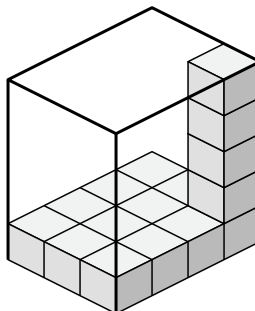

5)

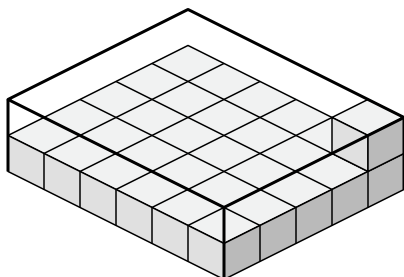

6)

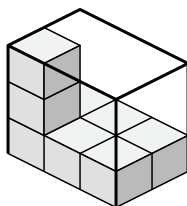

7)

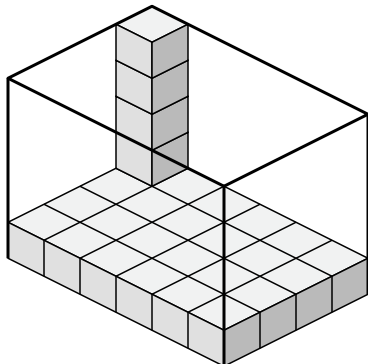

8)

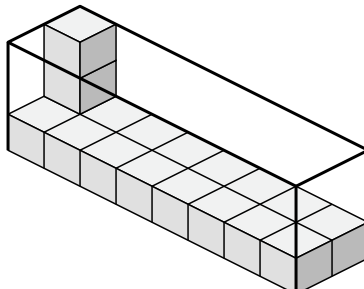

Answers

1. _____

2. _____

3. _____

4. _____

5. _____

6. _____

7. _____

8. _____



Determine the volume of each box. Each block is 1 cubic unit (u^3).

1)

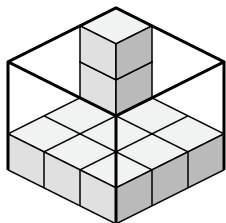

2)

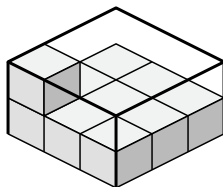

3)

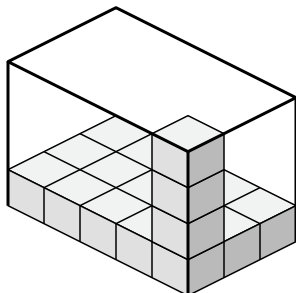

4)

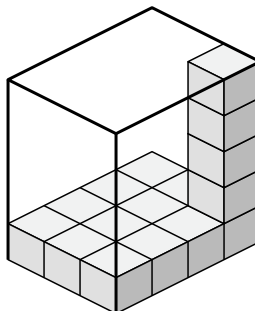

5)

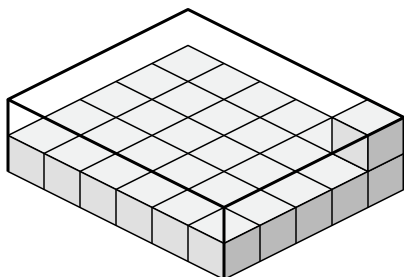

6)

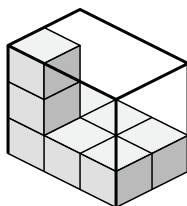

7)

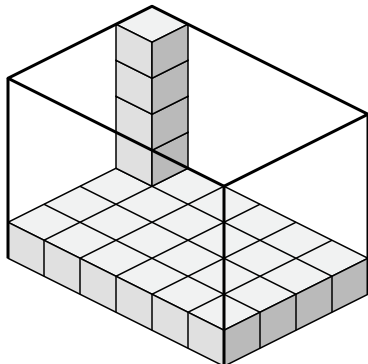

8)

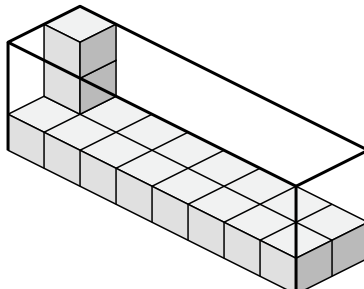

Answers

1. 27 u^3

2. 18 u^3

3. 60 u^3

4. 60 u^3

5. 60 u^3

6. 18 u^3

7. 120 u^3

8. 48 u^3



Determine the volume of each box. Each block is 1 cubic unit (u^3).

1)

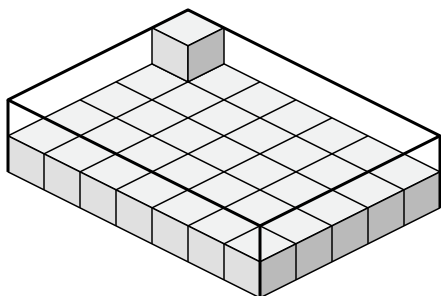

2)

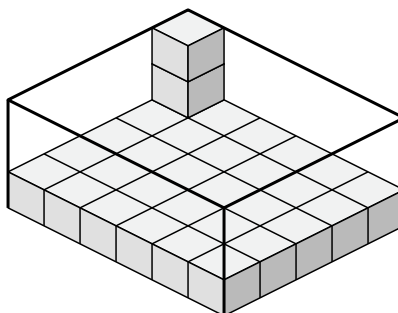

3)

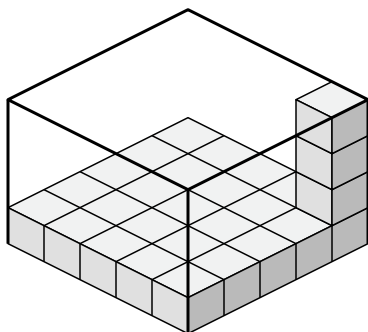

4)

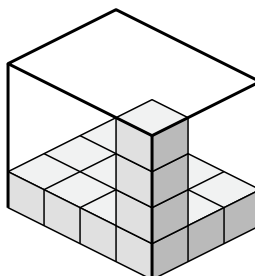

5)

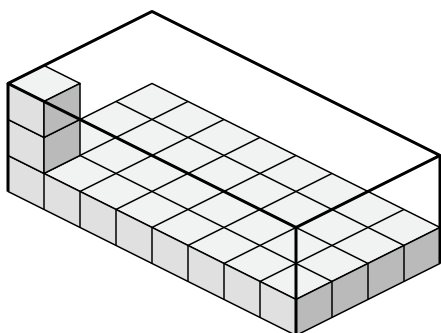

6)

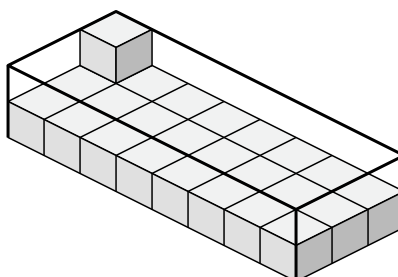

7)

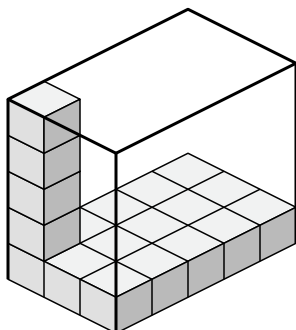

8)

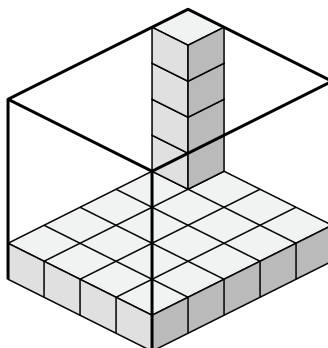

Answers

1. _____

2. _____

3. _____

4. _____

5. _____

6. _____

7. _____

8. _____



Determine the volume of each box. Each block is 1 cubic unit (u^3).

1)

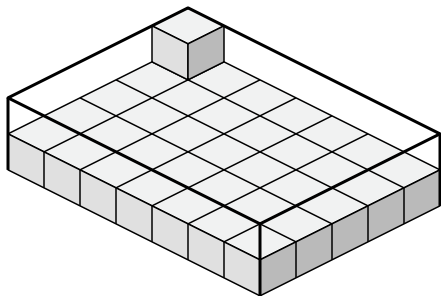

2)

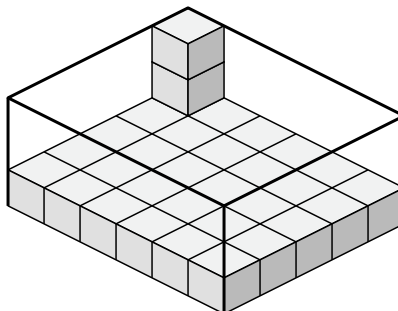

3)

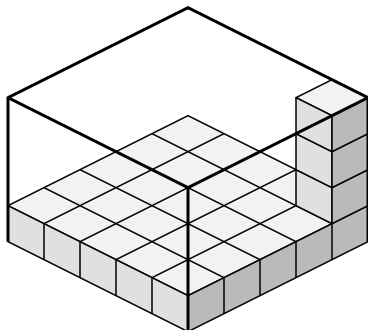

4)

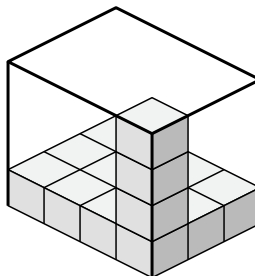

5)

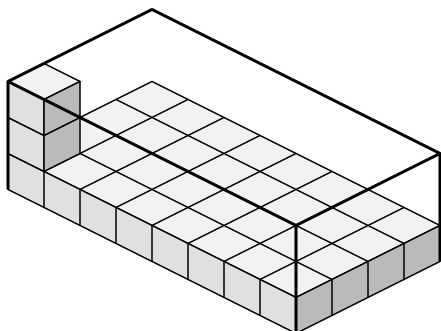

6)

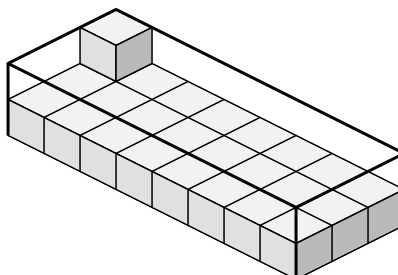

7)

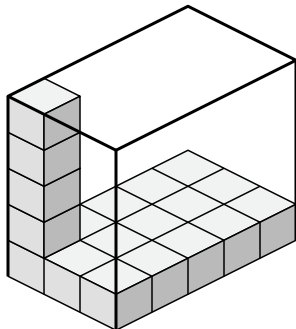

8)

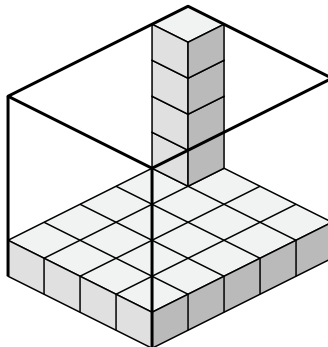

Answers

1. 70 u^3

2. 90 u^3

3. 100 u^3

4. 48 u^3

5. 96 u^3

6. 48 u^3

7. 75 u^3

8. 100 u^3