

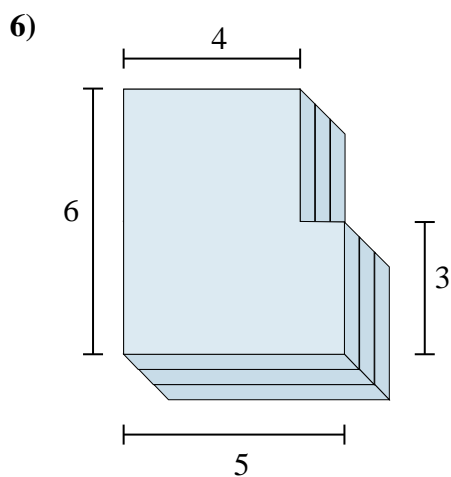

Find the total volume of each figure shown. Measured in cm (not to scale).

Answers

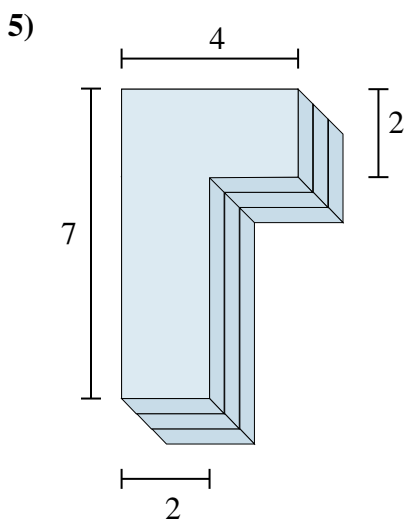
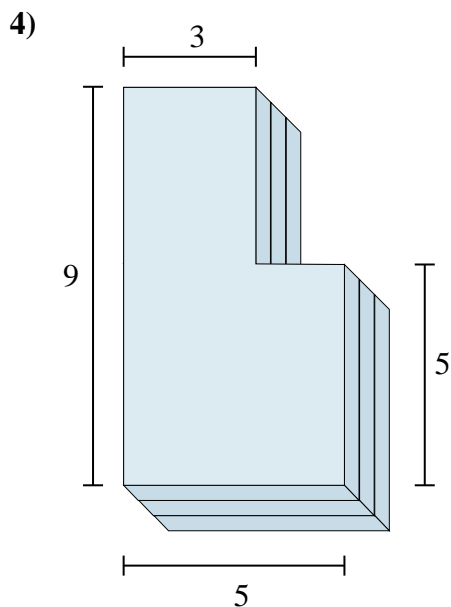
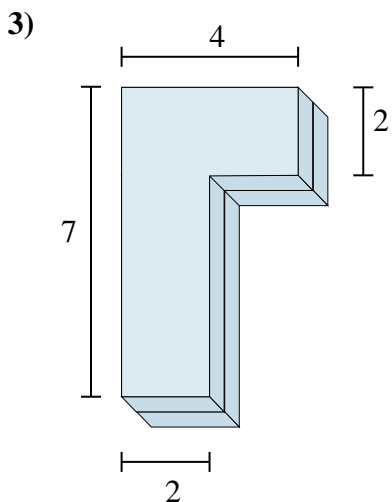
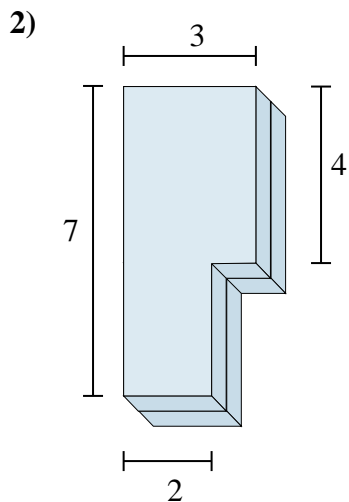
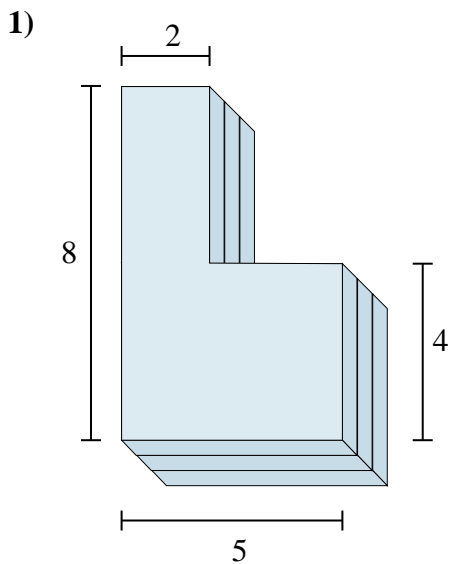

- 1. _____
- 2. _____
- 3. _____
- 4. _____
- 5. _____
- 6. _____



Find the total volume of each figure shown. Measured in cm (not to scale).

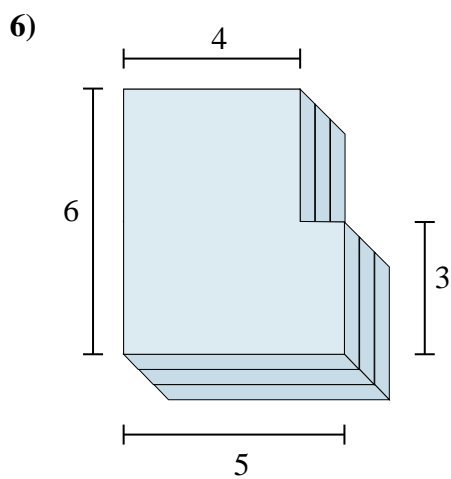
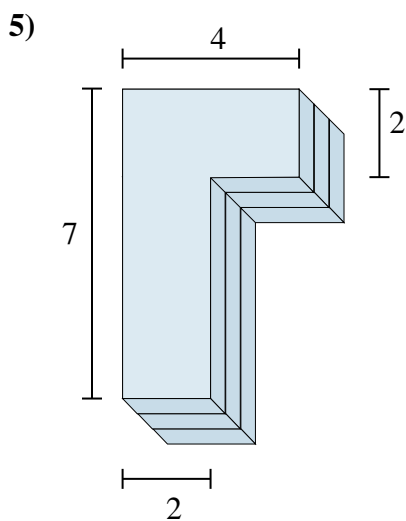
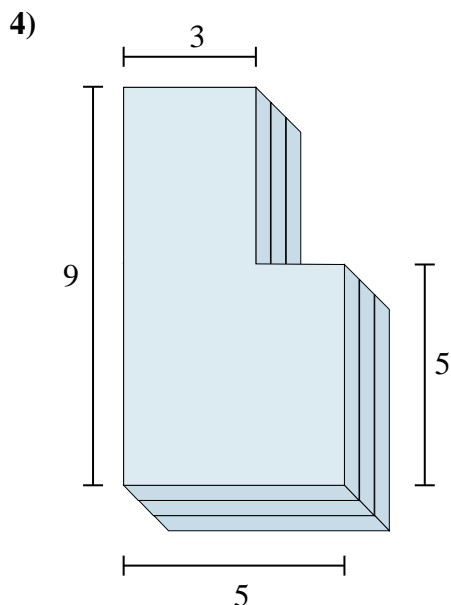
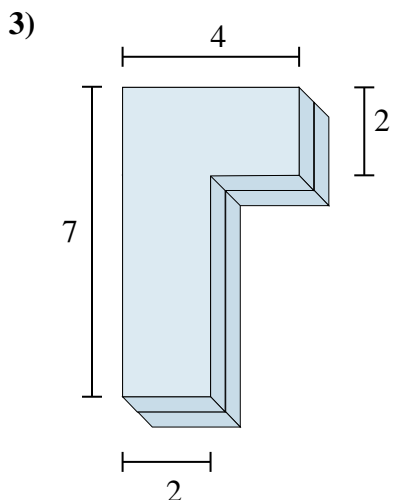
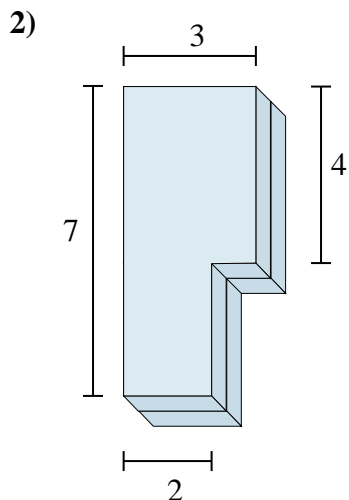
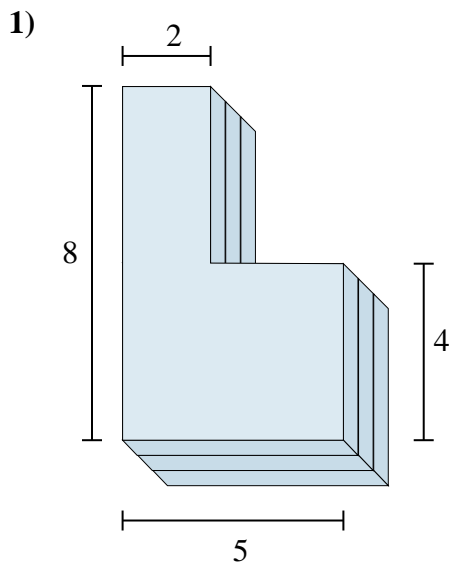

Answers

1. 84 cm³

2. 36 cm³

3. 36 cm³

4. 111 cm³

5. 54 cm³

6. 81 cm³



Find the total volume of each figure shown. Measured in cm (not to scale).

Answers

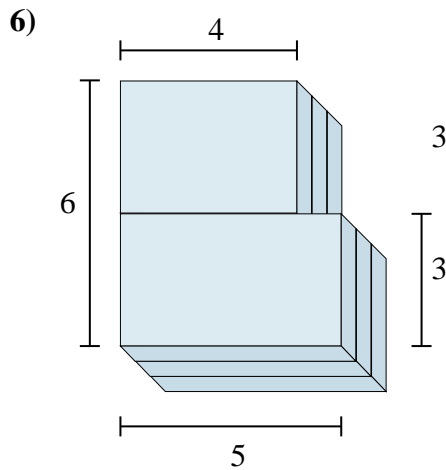
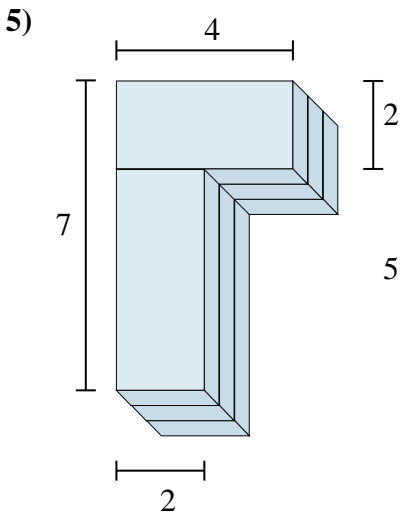
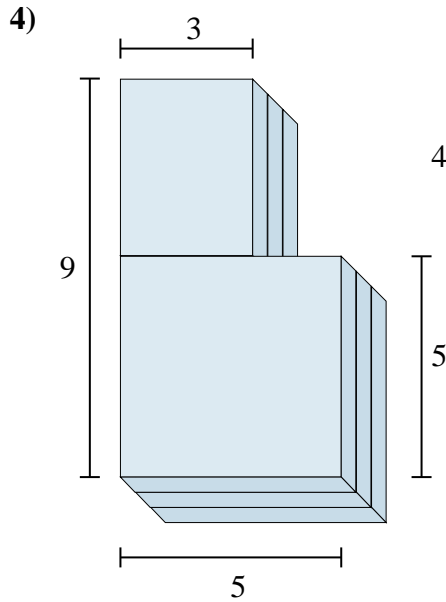
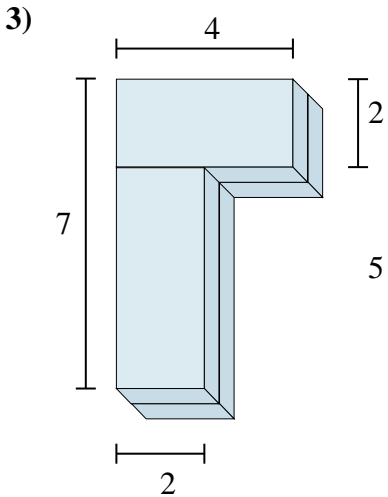
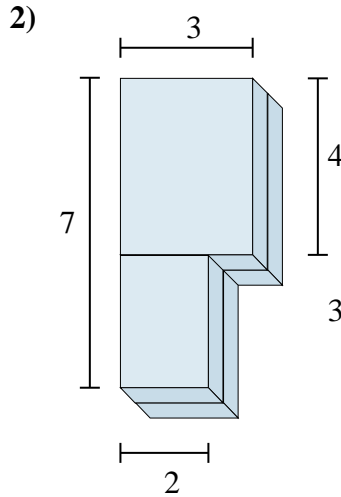
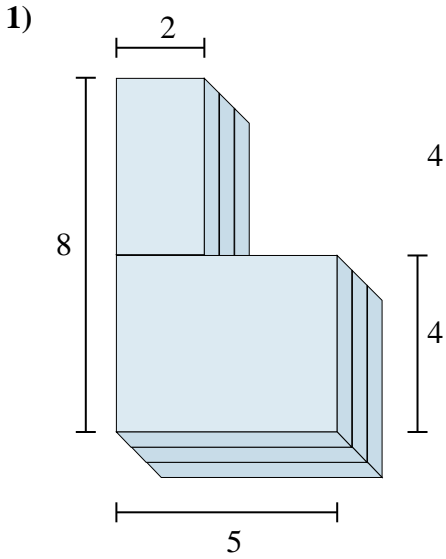

1. _____
2. _____
3. _____
4. _____
5. _____
6. _____